

**BLC İSKELE  
MÜHENDİSLİK A.Ş**

***KALIP ALTI***

***İSKELE SİSTEMİ***

***FORMWORK SCAFFOLDING SYSTEMS***

# Kalıp Altı İskele Sistemi

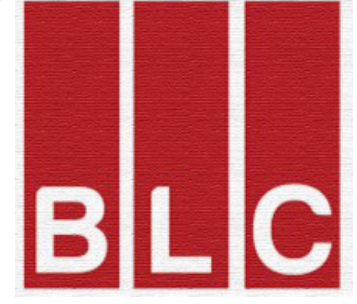

- İnşaat sektörü, güvenli ve verimli çalışma koşullarının sağlanması açısından çeşitli yapı destek sistemlerine ihtiyaç duyar. Bu bağlamda, BLC İskele & Kalıp olarak ürettiğimiz masa iskele, kalıp altı sistemleri ve teleskopik direk sistemleri, yapı projelerinin temel bileşenleri olarak öne çıkmaktadır. Masa iskele sistemleri, yüksek binaların yapımında işçilerin güvenli bir şekilde çalışabilmesi ve malzeme taşınmasının kolaylaştırılması için kullanılır. İskele sistemlerimiz, sağlam yapıları ve hızlı kurulumu sayesinde, inşaat projelerinde zaman ve maliyet tasarrufu sağlar.

Kalıp altı sistemleri, betonarme yapıların inşasında kalıpların altında kullanılan geçici destek yapılarıdır. Bu sistemler, beton dökümü sırasında kalıpların stabilitesini sağlamak ve betona istenilen şeklin verilmesine yardımcı olmak amacıyla kullanılır. BLC İskele & Kalıp olarak kalıp altı iskele sistemlerimiz, yüksek yük taşıma kapasiteleri ve esneklikleri ile farklı yapı elemanlarının formasyonunu destekler, böylece proje sürecinin her aşamasında güvenliği ve kaliteyi artırır.





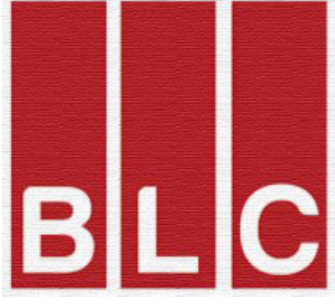

# Kalıp Altı İskele Sistemi

- Teleskopik direk sistemleri ise, inşaat projelerinde yükseklik ayarının kritik olduğu durumlarda kullanılan, ayarlanabilir direklerdir. Bu sistemler, özellikle farklı kat yüksekliklerinde beton dökümü ve kalıp kurulumunda esneklik sağlar. BLC İskele & Kalıp olarak teleskopik direklerimiz, taşıma kapasitesi ve dayanıklılığı ile uzun ömürlü bir kullanım sunar. Ayrıca, hafif ve kompakt yapıları sayesinde taşınması ve kurulumu kolaydır, bu da inşaat projelerinde operasyonel verimliliği artırır.

BLC İskele & Kalıp'ın sunduğu bu destek sistemleri, inşaat projelerinin her aşamasında güvenlik, hız ve etkinliği artıran temel unsurlar olarak kabul edilir. Sektördeki bu sistemlerin üretimi ve doğru kullanımı, inşaat sürecinin başarılı bir şekilde tamamlanmasına önemli katkılar sağlar.



# Kalıp Altı İskele Sistemi

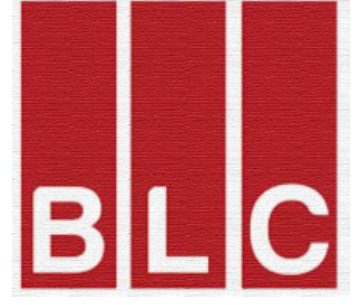

## GİRİŞ

BLC Kalıp Altı İskele Sistemi Ürün Kılavuzu TS EN 12810-1 standardına göre Kalıp Altı İskele Sistemi'nin tasarımı ve kullanımını sırasında gerekli olacak bilgileri içermektedir.

## Genel Bilgiler:

BLC İskele & Kalıp olarak ürettiğimiz masa iskele sistemleri, genellikle 1.20 m x 2.50 m ölçülerinde paneller ve 48.3 mm çapında, 3.0 mm kalınlığında çelik borular kullanılarak imal edilir. Bu yapılar, yüksek dayanıklılık ve yük taşıma kapasitesi sunar, bu sayede çeşitli inşaat projelerinde güvenle kullanılabilir.

Kalıp altı sistemlerinde, 100 cm ve 200 cm arası ayarlanabilir dikmeler ve 10 cm genişliğinde, 6 cm derinliğinde profiller tercih edilmektedir. Bu profiller, yüksek mukavemetli çelikten üretilir ve kalıpların stabilitesini sağlayarak, beton döküm işlemlerinin güvenli ve düzgün bir şekilde gerçekleştirilmesine olanak tanır.

Teleskopik direk sistemleri ise, genellikle 2 m ile 5.5 m arası yüksekliklerde ayarlanabilir. 48 mm çapında ve 3.2 mm kalınlığındaki çelik borular kullanılarak üretilen bu direkler, yükseklik ayarına ihtiyaç duyulan alanlarda esneklik sağlar. Her üç sistem de, yüksek kalite standartlarına uygun olarak üretilmekte olup, güvenlik ve dayanıklılık açısından test edilmiştir.





# Kalıp Altı İskele Sistemi

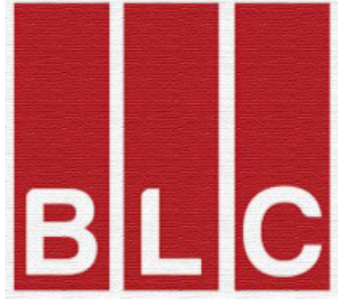

# Kalıp Altı İskele Sistemi

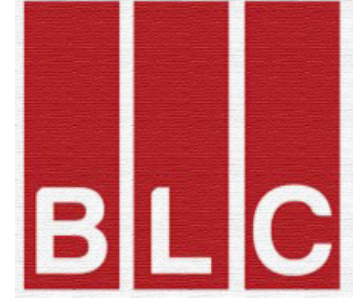

Yük Sınıfı	Düzgün yayılı yük $q_1$ kN/m <sup>2</sup>	500mm x 500mm alan üzerindeki tekil yük $F_1$ kN	500mm x 500mm alan üzerindeki tekil yük $F_1$ kN	Kısmi alan yükü	
				$q_2$ kN/m <sup>2</sup>	Kısmi alan kat sayısı $a_p$
1	0,75	1,50	1,00	-	-
2	1,50	1,50	1,00	-	-
3	2,00	1,50	1,00	-	-
4	3,00	3,00	1,00	5,00	0,4
5	4,50	3,00	1,00	7,00	0,4
6	6,00	3,00	1,00	10,00	0,5

## İskele Yük Sınıfının Belirlenmesi

- 1 İskele bölmesi gelecek yükler belirlenir:  
 $70 \times 1,2^* + 100 + 30 + 10 = 224 \text{ kg}$   
 $224 \text{ kg} = 2,24 \text{ kN}$

- 2 İskele bölmesinin alanı hesaplanır:  
 $2,50 \text{ m} \times 0,60 \text{ m} = 1,50 \text{ m}^2$

- 3 m<sup>2</sup>'ye gelecek yayılı yük hesaplanır:  
 $2,24 \text{ kN} / 1,50 \text{ m}^2 = 1,49 \text{ kN/m}^2$

- 4 Tablo 1'den uygun yük sınıfı tayin edilir:  
 $1,50 \text{ kN/m}^2 > 1,49 \text{ kN/m}^2$  olduğundan  
Yük sınıfı 2 seçilmelidir.

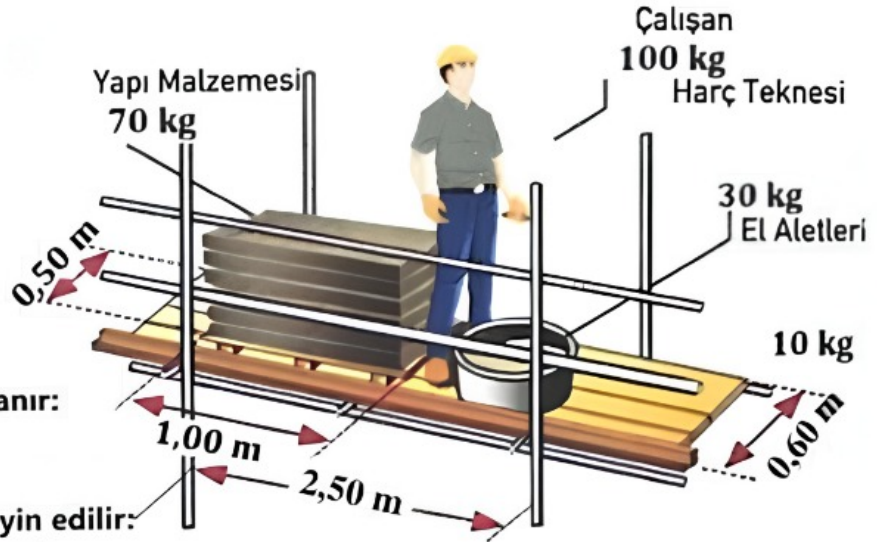



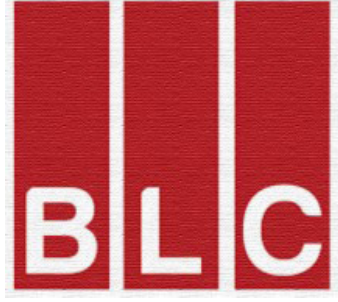

# Kalıp Altı İskele Sistemi

## SERTİFİKALARIMIZ..

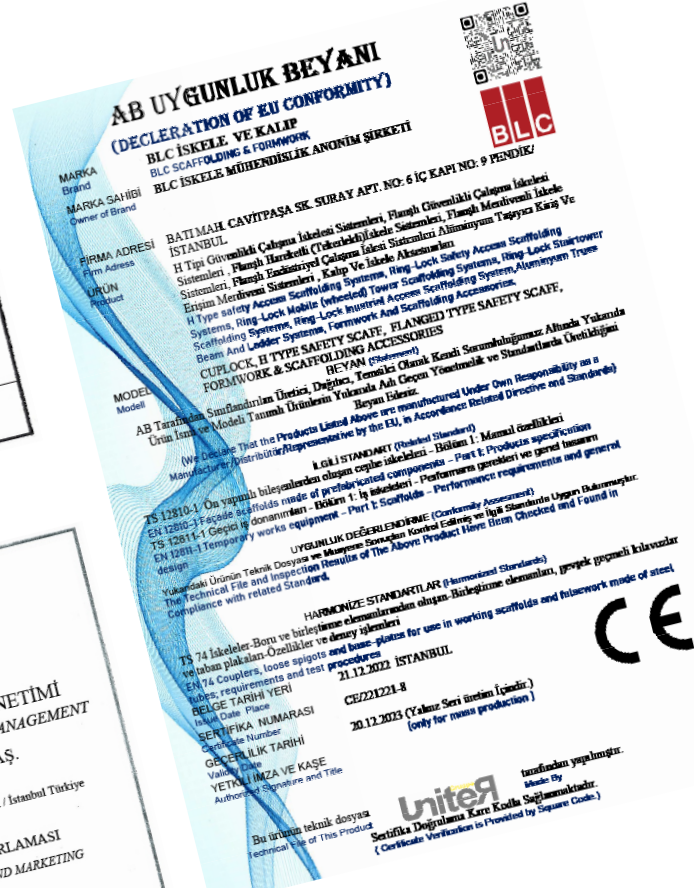

# Kalıp Altı İskele Sistemi

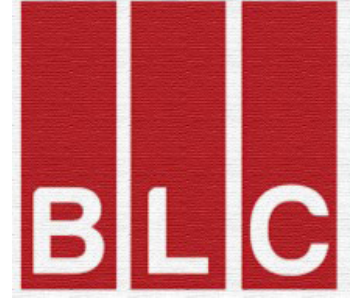

## KALIP ALTI İSKELE SİSTEMİ ÜRÜN LİSTESİ Formwork Scaffolding System Product List

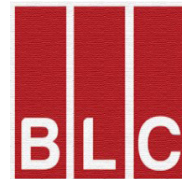
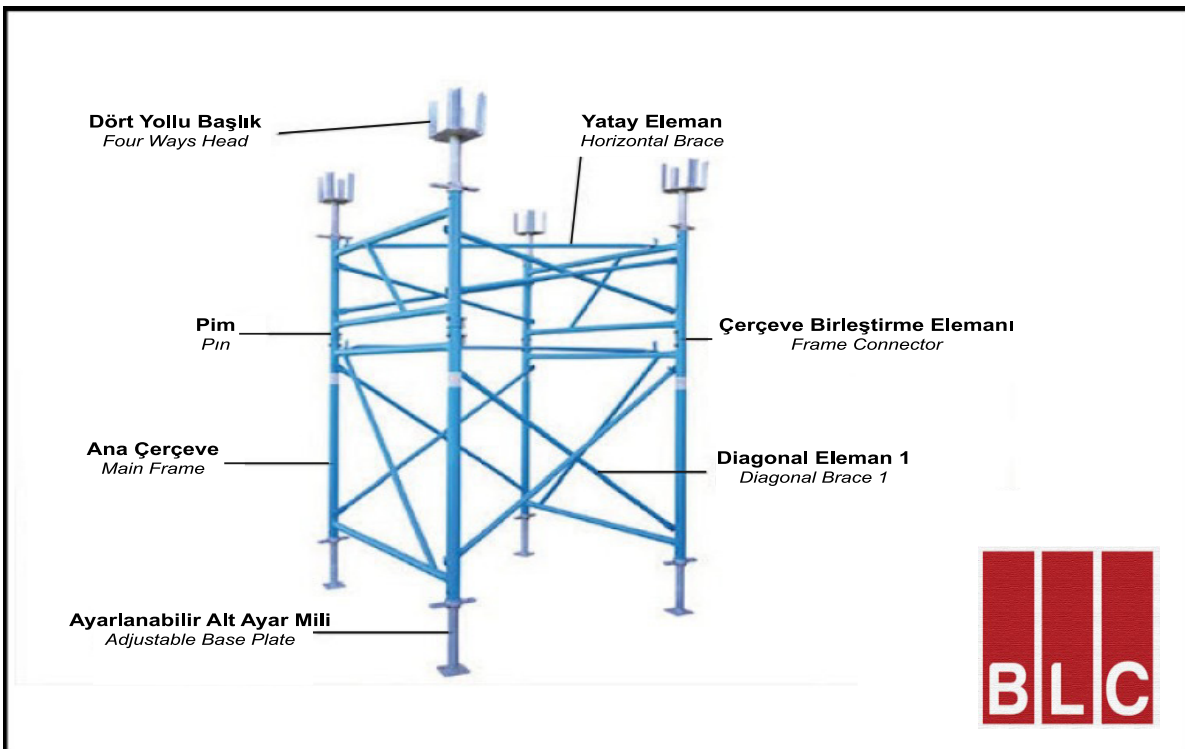
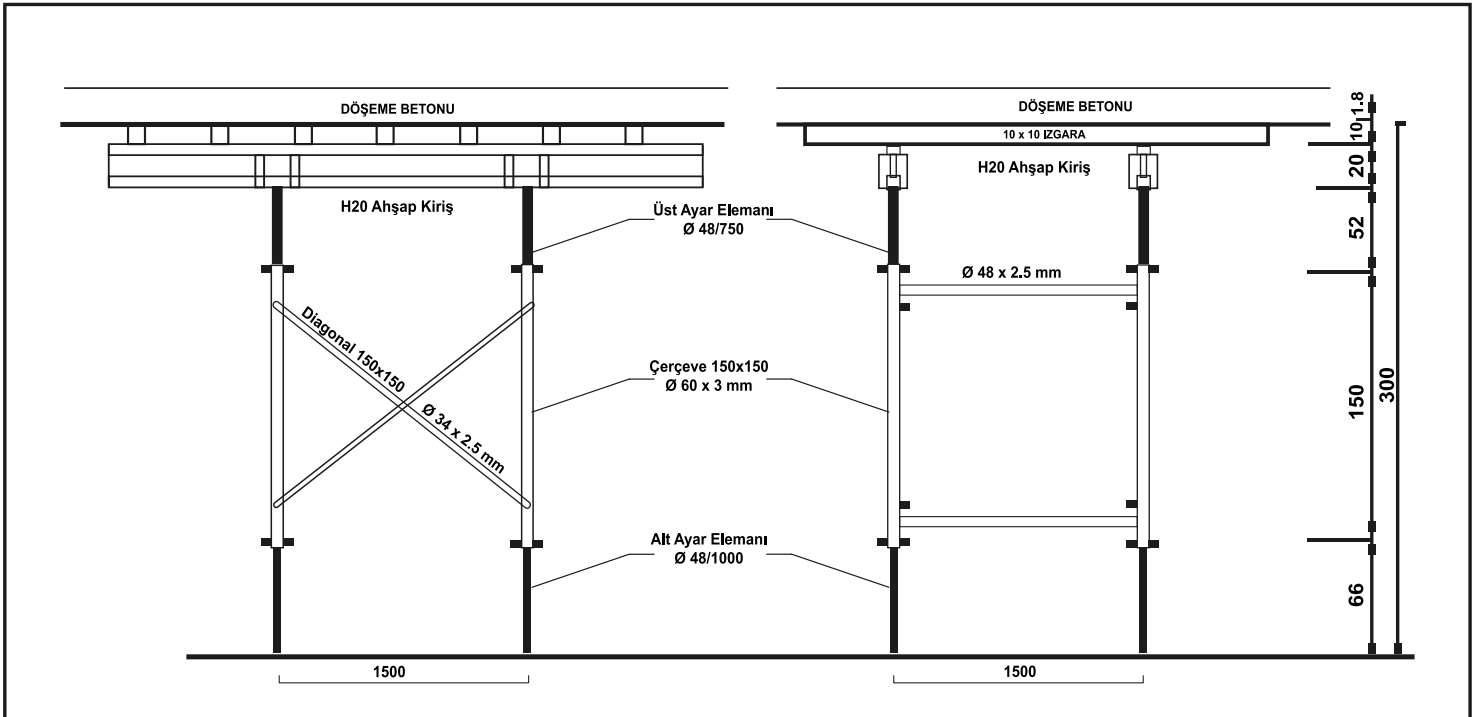



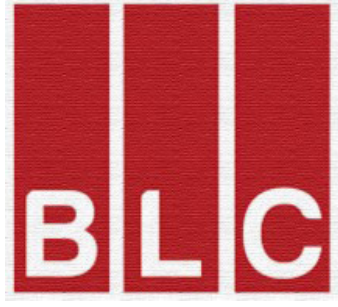



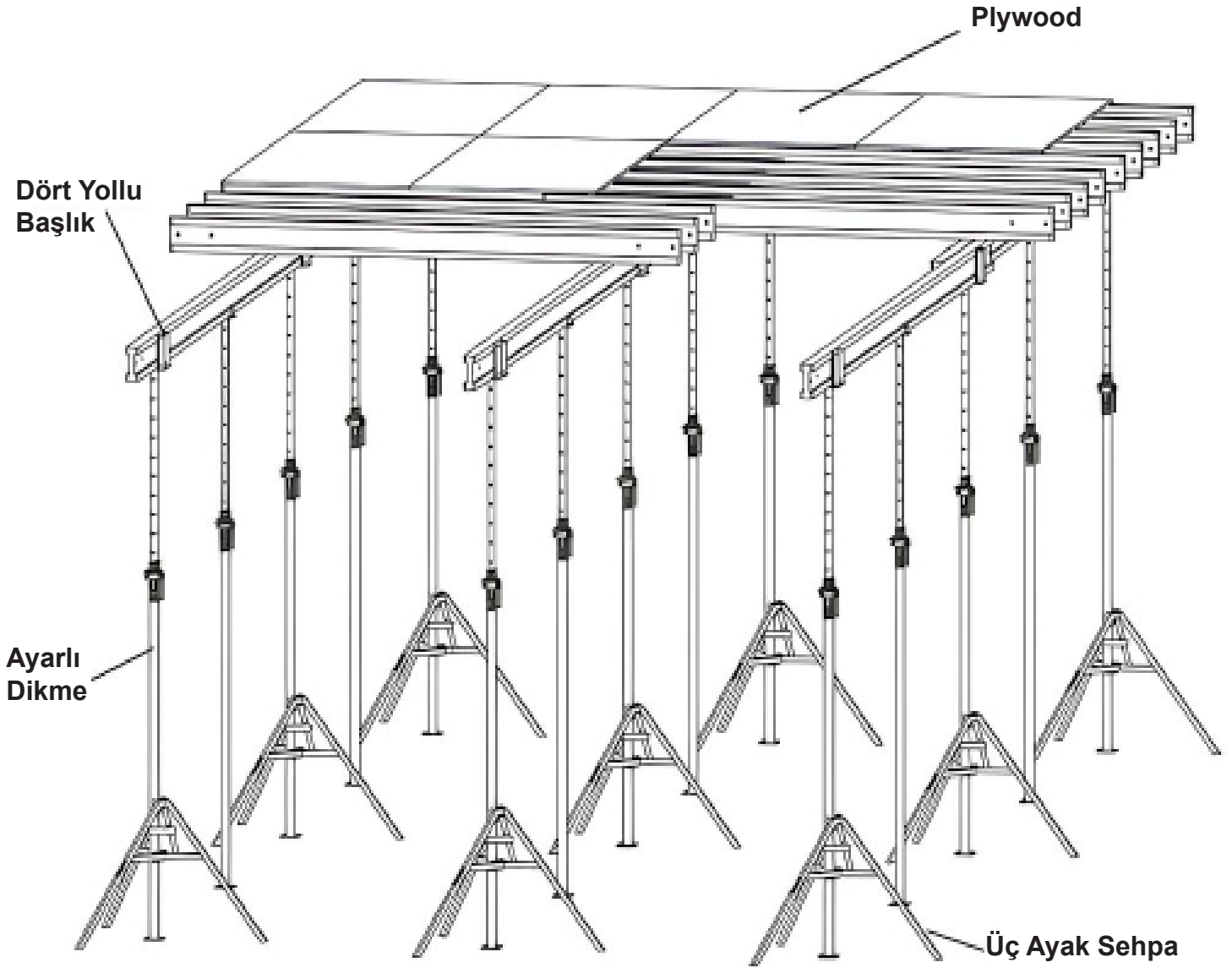

# Kalıp Altı İskele Sistemi

## *KALIP ALTI İSKELE SİSTEMİ ÜRÜN LİSTESİ* *Formwork Scaffolding System Product List*

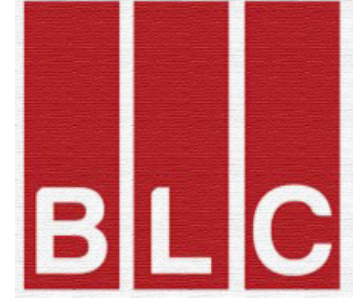

# Kalıp Altı İskele Sistemi



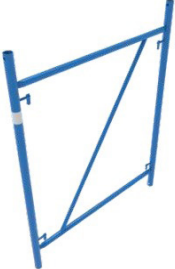

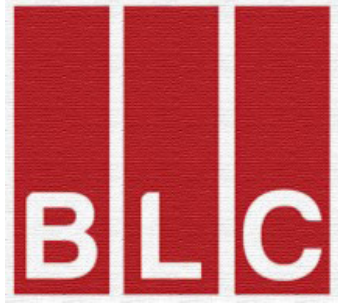

	ÜRÜN ADI Product Name	ÜRÜN KODU Product Code	BOY Size	AĞIRLIK Weight
	<b>ÇERÇEVE 150 X 120</b> <i>FRAME 150 X 120</i>			
	Ø60 + 3,0 mm Ø60 + 4,0 mm	61300001 61300002	150x120 CM 150x120 CM	19.50 KG 22.60 KG
	<b>ÇERÇEVE 150 X 150</b> <i>FRAME 150 X 150</i>			
	Ø60 + 3,0 mm Ø60 + 4,0 mm	61300003 61300004	150x150 CM 150x150 CM	22.10 KG 26.10 KG
	<b>ÇERÇEVE 150 X 180</b> <i>FRAME 150 X 180</i>			
	Ø60 + 3,0 mm Ø60 + 4,0 mm	61300005 61300006	150x120 CM 150x120 CM	24.80 KG 29.50 KG
	<b>ÇERÇEVE 150 X 200</b> <i>FRAME 150 X 200</i>			
	Ø60 + 3,0 mm Ø60 + 4,0 mm	61300007 61300008	150x120 CM 150x120 CM	26.40 KG 31.70 KG



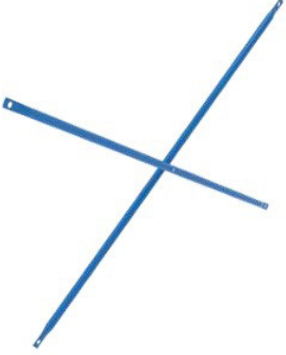





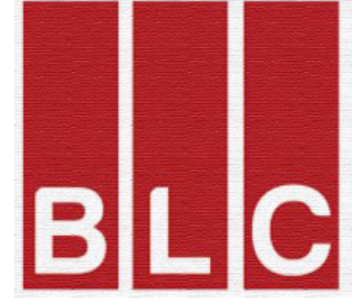

# Kalıp Altı İskele Sistemi

ÜRÜN ADI Product Name	ÜRÜN KODU Product Code	BOY Size	AĞIRLIK Weight
 ÇAPRAZ DIAGONAL	61300009	120X100 CM	4.00 KG
	61300010	120X150 CM	5.30 KG
	61300011	120X200 CM	6.60 KG
	61300012	120X250 CM	8.00 KG
	61300013	150X100 CM	4.70 KG
	61300014	150X150 CM	5.80 KG
	61300015	150X200 CM	7.10 KG
	61300016	150X250 CM	8.40 KG
	61300017	180-200X100 CM	5.40 KG
	61300018	180-200X150 CM	6.40 KG
	61300019	180-200X200 CM	7.50 KG
61300020	180-200X250 CM	8.70 KG	
 AYAR MİLİ Ø48 JACK Ø48	61300021	80 CM	3.70 KG
	61300022	100 CM	4.80 KG
	61300023	120 CM	5.80 KG
 ALT AYAR MİLİ Ø48 BASE JACK Ø48	61300024	80 CM	4.75 KG
	61300025	100 CM	6.70 KG
	61300026	120 CM	7.70 KG
 DÖRT YOLLU MİL FOUR WAYS JACK	61300027	80 CM	9.10 KG
	61300028	100 CM	10.20 KG
	61300029	120 CM	11.30 KG

# Kalıp Altı İskele Sistemi





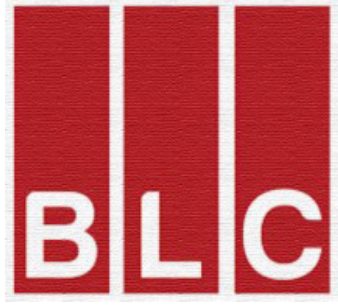

	ÜRÜN ADI Product Name	ÜRÜN KODU Product Code	BOY Size	AĞIRLIK Weight
	<b>DÖRT YOLLU BAŞLIK</b> <i>FOUR WAYS HEAD</i>	61300030	-----	4.30 KG
	<b>BAĞLAMA ELEMANI</b> <i>COUPLER BRACE</i>	61300031	-----	4.30 KG
	<b>KİRİŞ BAĞLAMA KÖŞEBENTİ</b> <i>GİRDER CONNECTOR</i>	61300032	40 CM	0.50 KG
	<b>AYAR MİLİ KANCASI</b> <i>JACK HOOK</i>	61300033	-----	0.10 KG
	<b>İSKELE EKLEME ELEMANI Ø60</b> <i>SCAFFOLD CONNECTION Ø60</i>	61300034	-----	0.50 KG







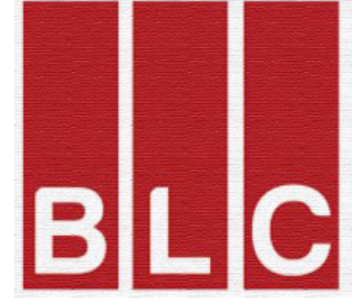

# Kalıp Altı İskele Sistemi

	<b>ÜRÜN ADI</b> Product Name	<b>ÜRÜN KODU</b> Product Code	<b>BOY</b> Size	<b>AĞIRLIK</b> Weight
	<b>PİM VE KOPİLYA</b> <i>PIN AND SPLIT PIN</i>	<b>61300035</b>	<b>16X80 CM</b>	<b>0.15 KG</b>
	<b>MASA TAŞIMA ARABASI</b> <i>TABLE CARRIER</i>	<b>61300036</b>	-----	<b>162.00 KG</b>
	<b>MASA TAŞIMA ÇATALI</b> <i>TABLE LIFTING COMPONENT</i>	<b>61300037</b>	-----	<b>230.00 KG</b>
	<b>MASA ALIN KORKULUĞU</b> <i>TABLE GUARDRAIL</i>	<b>61300038</b>	<b>145 CM</b>	<b>6.90 KG</b>
	<b>MASA ALIN KORKULUĞU SIKIŞTIRMASI</b> <i>TABLE GUARDRAIL COMPRESSIBLE</i>	<b>61300039</b>	<b>145 CM</b>	<b>7.20KG</b>

# Kalıp Altı İskele Sistemi



	ÜRÜN ADI Product Name	ÜRÜN KODU Product Code	BOY Size	AĞIRLIK Weight
	<b>SIKIŞTIRMALI DÖŞEME KORKULUĞU</b> <i>COMPRESSIBLE SLAB GUARDRAIL</i>	<b>61300040</b>	<b>145 CM</b>	<b>8.00 KG</b>
	<b>BORU Ø48 X 2.5</b> <i>TUBE Ø48X 2.5</i>	<b>61300041</b> <b>61300042</b> <b>61300043</b> <b>61300044</b> <b>61300045</b> <b>61300046</b>	<b>100 CM</b> <b>150 CM</b> <b>200 CM</b> <b>300 CM</b> <b>400 CM</b> <b>600 CM</b>	<b>2.55 KG</b> <b>3.70 KG</b> <b>5.10 KG</b> <b>7.70 KG</b> <b>10.20 KG</b> <b>15.40 KG</b>
	<b>HAREKETLİ KELEPÇE</b> <i>SWIWEL COUPLER</i>		<b>1.5X1.5 CM</b> <b>1.5X 2.0 CM</b>	<b>1.00 KG</b> <b>1.25 KG</b>
	<b>ÜNİVERSAL ÇELİK KUŞAK</b> <i>UNIVERSAL STEEL WALER</i>	<b>61300049</b> <b>61300050</b> <b>61300051</b> <b>61300052</b> <b>61300053</b> <b>61300054</b> <b>61300055</b> <b>61300056</b> <b>61300057</b> <b>61300058</b> <b>61300059</b> <b>61300060</b> <b>61300061</b> <b>61300062</b> <b>61300063</b> <b>61300064</b> <b>61300065</b> <b>61300066</b> <b>61300067</b> <b>61300068</b> <b>61300069</b> <b>61300070</b>	<b>70 CM</b> <b>90 CM</b> <b>120 CM</b> <b>145 CM</b> <b>170 CM</b> <b>195 CM</b> <b>220 CM</b> <b>245 CM</b> <b>270 CM</b> <b>295 CM</b> <b>320 CM</b> <b>345 CM</b> <b>370 CM</b> <b>395 CM</b> <b>420 CM</b> <b>445 CM</b> <b>470 CM</b> <b>495 CM</b> <b>520 CM</b> <b>545 CM</b> <b>570 CM</b> <b>595 CM</b>	<b>17.50 KG</b> <b>23.75 KG</b> <b>30.00 KG</b> <b>36.25 KG</b> <b>42.50 KG</b> <b>48.75 KG</b> <b>55.00 KG</b> <b>61.25 KG</b> <b>67.50 KG</b> <b>73.75 KG</b> <b>80.00 KG</b> <b>86.25 KG</b> <b>92.50 KG</b> <b>98.75 KG</b> <b>105.00 KG</b> <b>111.25 KG</b> <b>117.50 KG</b> <b>123.75 KG</b> <b>130.00 KG</b> <b>136.25 KG</b> <b>142.50 KG</b> <b>148.75 KG</b>



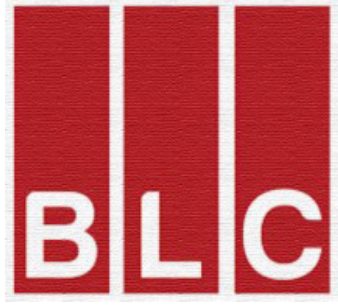



# Kalıp Altı İskele Sistemi

	<b>ÜRÜN ADI</b> Product Name	<b>ÜRÜN KODU</b> Product Code	<b>BOY</b> Size	<b>AĞIRLIK</b> Weight
	<b>ÜNİVERSAL ÇELİK KUŞAK BİRLEŞTİRME ELEMANI</b> <i>UNIVERSAL STEEL WALER COUPLER</i>	<b>61300071</b>	<b>75 CM</b>	<b>13.00 KG</b>
	<b>ÜNİVERSAL KUŞAK KANCASI</b> <i>UNIVERSAL WALER HOOK</i>	<b>61300072</b>	-----	<b>1.00 KG</b>
	<b>ALT AYAR MİLİ Ø38</b> <i>JACK Ø38</i>	<b>61300073</b> <b>61300074</b>	<b>70 CM</b> <b>100 CM</b>	<b>3.10 KG</b> <b>4.30 KG</b>
	<b>DÖRT YOLLU MİL Ø38</b> <i>FOUR WAYS JACK Ø38</i>	<b>61300075</b> <b>61300076</b>	<b>70 CM</b> <b>100 CM</b>	<b>7.30 KG</b> <b>8.10 KG</b>
	<b>İSKELE EKLEME ELEMANI Ø48</b> <i>SCAFFOLD CONNECTION Ø48</i>	<b>61300077</b>	-----	<b>0.30 KG</b>

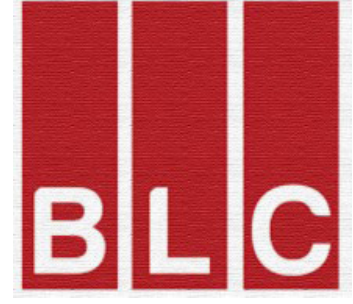
# Kalıp Altı İskele Sistemi

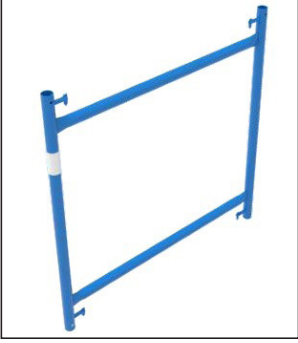

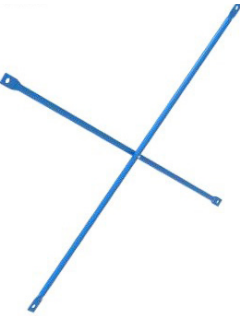

	ÜRÜN ADI Product Name	ÜRÜN KODU Product Code	BOY Size	AĞIRLIK Weight
	ÇERÇEVE 120X120 <i>FRAME 12X120</i>	61300078	120X120 CM	14.30 KG
	ÇERÇEVE 120X150 <i>FRAME 12X150</i>	61300079	120X150 CM	16.20 KG
	ÇERÇEVE 120X180 <i>FRAME 12X180</i>	61300080	120X180 CM	20.80 KG
	ÇAPRAZ <i>DIAGONAL</i>	61300081	180X120 CM	4.20 KG

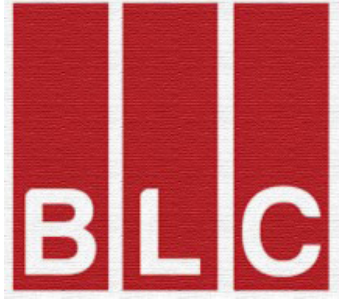



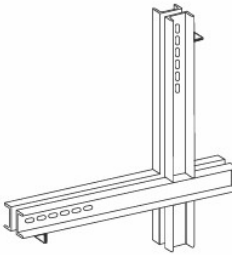
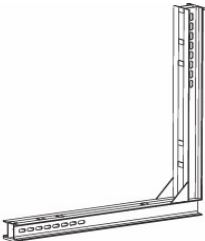
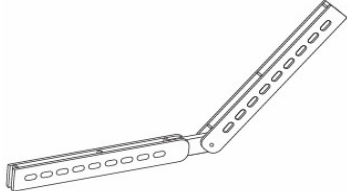

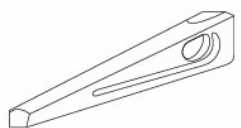
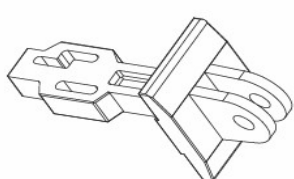
# Kalıp Altı İskele Sistemi

	ÜRÜN ADI Product Name	ÜRÜN KODU Product Code	BOY Size	AĞIRLIK Weight
	<b>İÇ KÖŞE KUŞAĞI</b> <i>INNER CORNER WALER</i>	61300082	75 CM	31.50 KG
		61300083	100 CM	36.75 KG
		61300084	50 CM	37.75 KG
		61300085	75 CM	42.00 KG
		61300086	100 CM	47.25 KG
		61300087	125 CM	52.50 KG
		61300088	75 CM	47.25 KG
	<b>KOLON KUŞAĞI</b> <i>COLUMN WALER</i>	61300089	40 CM	32.00 KG
		61300090	50 CM	36.00 KG
		61300091	60 CM	41.00 KG
		61300092	70 CM	45.00 KG
		61300093	80 CM	49.00 KG
		61300094	90 CM	53.00 KG
		61300095	100 CM	59.00 KG
	<b>HAREKETLİ KUŞAK EKLEME ELEMANI</b> <i>WALER CONNECTOR</i>	61300096	60X60 CM	12.00 KG
		61300097	100X100 CM	20.00 KG
	<b>DIŞ CEPHE BİRLEŞTİRME ELEMANI</b> <i>OUTER CORNER CONNECTOR</i>	61300098	100 CM	2.40 KG
	<b>KUŞAK KAMASI</b> <i>WALER WEDGE</i>	61300099	100 CM	0.75 KG
	<b>PAYANDA BAŞLIĞI</b> <i>PUSH-PULL PROD HEAD</i> <b>ÜÇ GÖZLÜ</b> <b>TEK GÖZLÜ</b>	61300100	100 CM	2.07 KG
		61300101	100 CM	1.80 KG

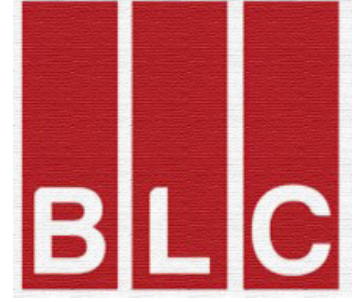
# Kalıp Altı İskele Sistemi

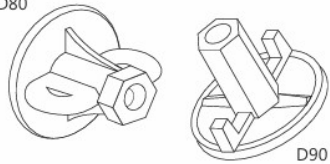
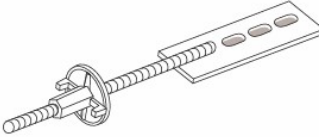
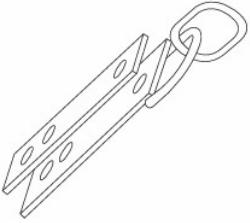

	ÜRÜN ADI Product Name	ÜRÜN KODU Product Code	BOY Size	AĞIRLIK Weight
	<b>AKSESUAR KAMASI</b> <i>ACCESSORIES WEDGE</i>			
	6 MM	61300102	100 CM	0.29 KG
	8 MM	61300103	100 CM	0.37 KG
	<b>TİE ROT AYNASI</b> <i>TIEROD PLATE</i> 110X110X4 AYNA 100X100X8 AYNA 100X100X10 AYNA	61300104	120 CM	0.45 KG
	<b>TİE ROT SOMUNU</b> <i>ACCESSORIES WEDGE</i>			
	KELEBEK SOMUN	61300105	-----	0.35 KG
	TIRNAKLI SOMUN	61300106	-----	0.45 KG
	<b>ALIN BAĞLANTI ELEMANI</b> <i>STOPEND</i>	61300107	-----	2.50 KG
	<b>VİNÇ TAŞIMA KANCASI</b> <i>CRANE HOOK</i>	61300108	-----	4.50 KG

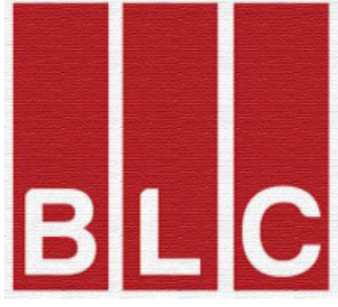

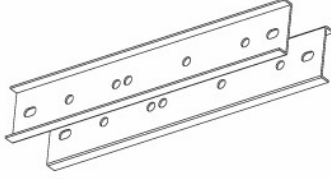
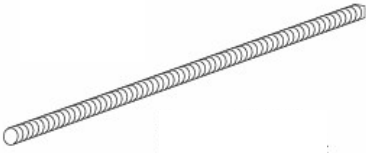
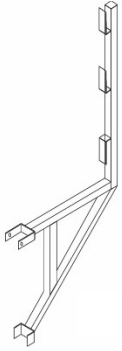
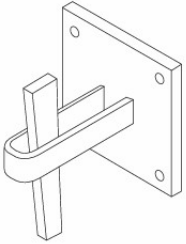
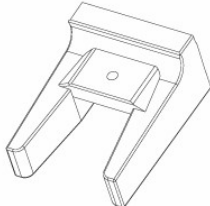

# Kalıp Altı İskele Sistemi

	ÜRÜN ADI Product Name	ÜRÜN KODU Product Code	BOY Size	AĞIRLIK Weight
	<b>H20 BİRLEŞTİRME ELEMANI</b> <i>H20 EXTENSION ELEMENT</i>	61300109	70 CM	7.12 KG
	<b>TİE ROT MİLİ</b> <i>TIEROD</i>	61300110 61300111 61300112 61300113	100 CM 120 CM 150 CM 200 CM	1.50 KG 1.80 KG 2.25 KG 3.00 KG
	<b>ÇALIŞMA KONSOLU</b> <i>WORKING CONSOLE</i>	61300114	-----	11.00 KG
	<b>H20 ADAPTÖRÜ</b> <i>H20 ADAPTERE</i>	61300115	-----	1.65 KG
	<b>KİRİŞ SIKIŞTIRMA ELEMANI</b> <i>END CLAMP</i>	61300116	-----	0.70 KG



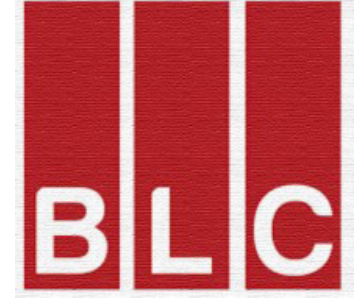

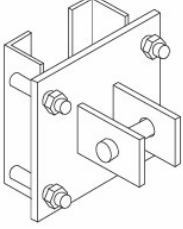
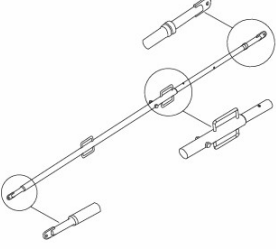
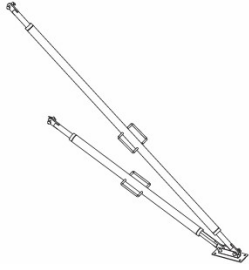
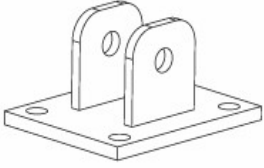
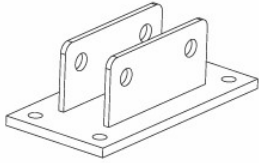
# Kalıp Altı İskele Sistemi

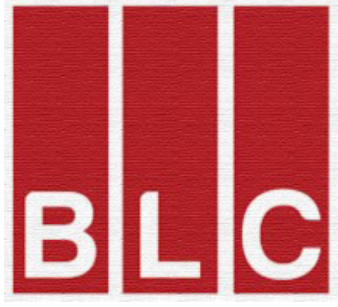

	ÜRÜN ADI Product Name	ÜRÜN KODU Product Code	BOY Size	AĞIRLIK Weight
	<b>H20 PAYANDA BAĞLAMA ADPTÖRÜ</b> <i>PUSH-PULL PROP HEAD FOR H20 BEAM</i>	61300117	-----	2.00 KG
		61300117	245 CM	42.00 KG
		61300118	265 CM	45.00 KG
		61300119	290 CM	45.00 KG
		61300120	330/360 CM	50.00 KG
		61300121	390 CM	52.00 KG
		61300122	420 CM	53.00 KG
		61300123	450/490 CM	66.00 KG
	61300124	590 CM	77.00 KG	
	<b>DEV PAYANDA</b> <i>SUPPORTER PROP</i> 76X4 60X4	61300125	-----	90.46 KG
	<b>TEK KOLLU PAYANDA TABANI</b> <i>PUSH-PULL PROP BASE PLATE FOR SINGLE</i>	61300126	-----	1.80 KG
	<b>ÇİFT KOLLU PAYANDA TABANI</b> <i>PUSH-PULL PROP BASE PLATE FOR DOUBLE</i>	61300127	-----	2.90 KG
	<b>ÇEKTİRME MİLİ</b> <i>PULLING BAR</i>	61300128	-----	2.10 KG

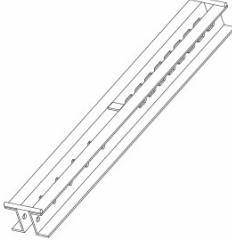
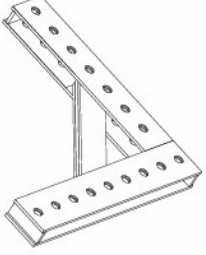

# Kalıp Altı İskele Sistemi

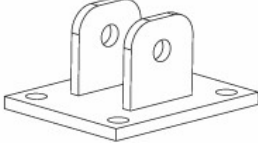
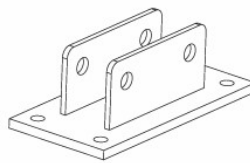
	<b>ÜRÜN ADI</b> Product Name	<b>ÜRÜN KODU</b> Product Code	<b>BOY</b> Size	<b>AĞIRLIK</b> Weight	
	<b>AYARLANABİLİR KOLON KUŞAĞI</b> <i>ADJUSTABLE COLUMN WALER</i>	<b>61300129</b> <b>61300130</b>	<b>115 CM</b> <b>145 CM</b>	<b>23.00 KG</b> <b>30.00 KG</b>	
		<b>AYARLANABİLİR KÖŞE GÖNYESİ</b> <i>ADJUSTABLE CORNER COMPONENT</i>	<b>61300131</b>	----- <b>9.00 KG</b>	
	<b>TEK YÜZ PAYANDA</b> <i>ONE FACE PROP</i>	<b>61300132</b> <b>61300133</b> <b>61300134</b> <b>61300135</b> <b>61300136</b> <b>61300137</b> <b>61300138</b> <b>61300139</b> <b>61300140</b> <b>61300141</b> <b>61300142</b>	<b>100 CM</b> <b>150 CM</b> <b>200 CM</b> <b>250 CM</b> <b>300 CM</b> <b>350 CM</b> <b>400 CM</b> <b>450 CM</b> <b>500 CM</b> <b>550 CM</b> <b>600 CM</b>	<b>31.00 KG</b> <b>38.50 KG</b> <b>45.50 KG</b> <b>52.90 KG</b> <b>60.00 KG</b> <b>67.00 KG</b> <b>74.50 KG</b> <b>81.50 KG</b> <b>89.00 KG</b> <b>96.00 KG</b> <b>103.00 KG</b>	
		<b>TEK YÜZ PAYANDA KAFASI</b> <i>PUSH-PULL PROP BASE PLATE FOR SINGLE</i>	<b>61300143</b>	-----	<b>9.00 KG</b>
		<b>TEK YÜZ PAYANDA TABANI</b> <i>PUSH-PULL PROP BASE PLATE FOR DOUBLE</i>	<b>61300144</b>	-----	<b>9.00 KG</b>

# Kalıp Altı İskele Sistemi

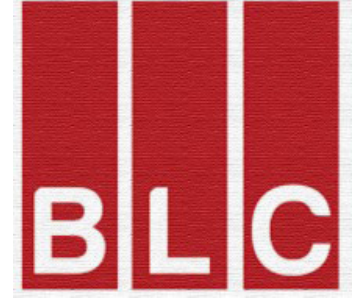

	ÜRÜN ADI Product Name	ÜRÜN KODU Product Code	BOY Size	AĞIRLIK Weight
	<b>YATAY DESTEK KUŞAĞI</b> <i>CLİ</i>	61300145	50 CM	13.40 KG
		61300146	200 CM	53.60 KG
		61300147	225 CM	60.30 KG
		61300148	250 CM	67.00 KG
		61300149	275 CM	73.70 KG
	<b>DİKEY KUŞAK</b> <i>CLİ</i>	61300150	250 CM	67.00 KG
		61300151	300 CM	80.40 KG
		61300152	350 CM	93.80 KG
		61300153	375 CM	100.50 KG
		61300154	400 CM	107.20 KG
		61300155	450 CM	120.60 KG
61300156	500 CM	134.00 KG		
	<b>TIRMANMA KONSOLU 150-200</b> <i>CLIMBING BRACKET 150-200</i>	61300157	150 CM	69.50 KG
		61300158	200 CM	93.00 KG
		61300159	250 CM	116.80 KG
		61300160	300 CM	139.00 KG
	<b>TIRMANMA KONSOLU 250-300</b> <i>CLIMBING BRACKET 250-300</i>	61300161	150 CM	58.00 KG
		61300162	200 CM	68.50 KG
		61300163	250 CM	90.00 KG
		61300164	300 CM	120.00 KG
	<b>AYARLANABİLİR KÖŞE BAĞLANTI PİMİ</b> <i>ADJUSTABLE CORNER PIM</i>	61300165	-----	0.20 KG



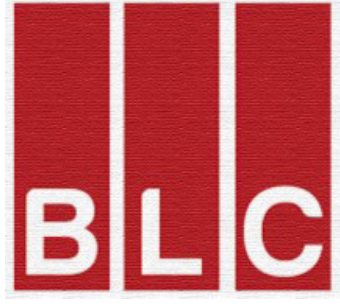

# Kalıp Altı İskele Sistemi

	ÜRÜN ADI Product Name	ÜRÜN KODU Product Code	BOY Size	AĞIRLIK Weight
	<b>FİRKETE</b> <i>COTTER</i>	61300166	-----	0.03 KG
	<b>TIRMANMA ASKISI</b> <i>CLIMBING CONE</i>	61300167	-----	0.90 KG
	<b>PLASTİK KILIF</b> <i>SEALING SLEEVE</i>	61300168	-----	0.01KG
	<b>ÜÇGEN ANAHTAR</b> <i>POSITIONING CONE SPANNER</i>	61300169	-----	0.30 KG
	<b>KALICI ANKRAJ</b> <i>STOP ANCHOR</i>	61300170 61300171 61300172 61300173 61300174	16 CM 40 CM 80 CM 100 CM 120 CM	0.70 KG 1.10 KG 1.50 KG 1.90 KG 2.30 KG
	<b>FLANŞLI SU TUTUCU</b> <i>WATER STOPPER</i>	61300175	-----	0.50 KG

# Kalıp Altı İskele Sistemi

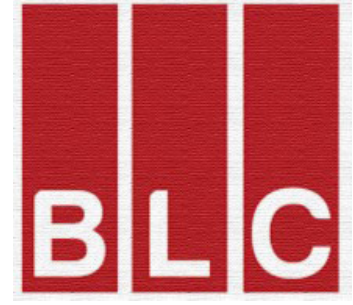

	ÜRÜN ADI Product Name	ÜRÜN KODU Product Code	BOY Size	AĞIRLIK Weight
	<b>ŞAFT PLATFORM KİRİŞİ</b> <i>SHAFT WALER</i>	61300176	100 CM	33.08 KG
		61300177	150 CM	50.07 KG
		61300178	200 CM	67.06 KG
	<b>ŞAFT PLATFORM ASKISI</b> <i>SHAFT PLATFORM CARRIER</i>	61300179	-----	7.80 KG
		61300180	-----	7.80 KG
	<b>TEK YÜZLÜK PAYANDASI (100X100X5)</b>  <i>SHAFT WALER (100X100X5)</i>	61300181	100 CM	93.90 KG
		61300182	125 CM	105.00 KG
		61300183	150 CM	115.50 KG
		61300184	175 CM	126.30 KG
		61300185	200 CM	137.10 KG
		61300186	225 CM	147.90 KG
		61300187	250 CM	158.70 KG
		61300188	300 CM	180.30 KG
		61300189	350 CM	210.90 KG
		61300190	375 CM	212.70 KG
		61300191	400 CM	222.90 KG
		61300192	450 CM	245.10 KG
61300193	500 CM	266.70 KG		
61300194	550 CM	288.30 KG		
61300195	600 CM	309.90 KG		
	<b>REZERVASYON</b> <i>REZERVATION</i>	61300196	-----	1.2 KG

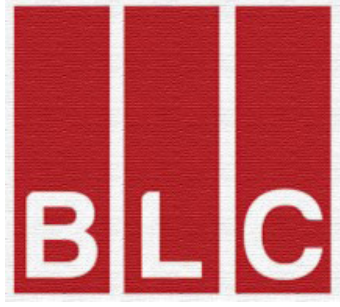



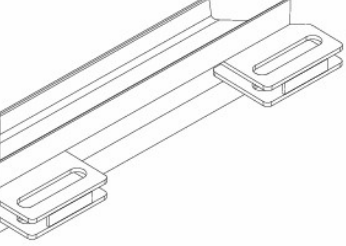
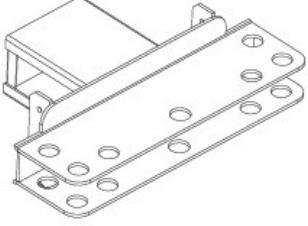
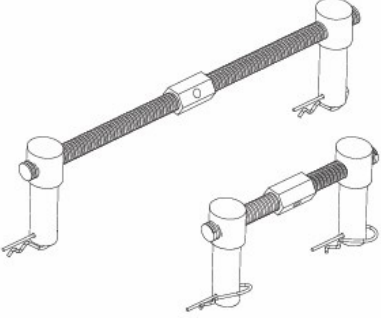
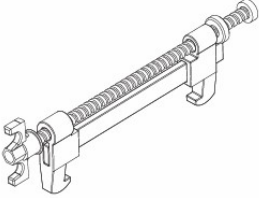
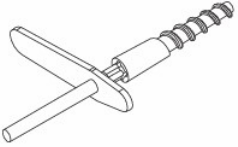

# Kalıp Altı İskele Sistemi

	ÜRÜN ADI Product Name	ÜRÜN KODU Product Code	BOY Size	AĞIRLIK Weight
	<b>DAİRESEL PERDE KUŞAĞI</b> <i>CIRCULAR WALER</i>	61300197	-----	14.02 KG
	<b>KİRİŞ DESTEK ELEMANI</b> <i>SUPPORTER COMPONENT</i>	61300198	-----	8.3 KG
	<b>AYAR ELEMANI</b> <i>ADJUSTMENT COMPONENT</i>	61300199 61300200	25 CM 50 CM	2.1 KG 2.8 KG
	<b>AYARLANABİLİR KİLİT</b> <i>ADJUSTABLE CLAMP</i>	61300201	-----	3.0 KG
	<b>YER TUTUCU (HAVUÇ)</b> <i>POSITIONING CONE</i>	61300202 61300203 61300204 61300205	25 CM 30 CM 35 CM 40 CM	1.70 KG 2.00 KG 2.40 KG 2.90 KG
	<b>HAVUÇ SÖKME ANAHTARI</b>	61300206	-----	2.00 KG

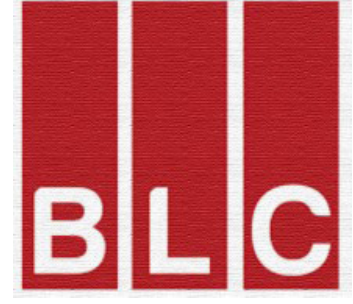

# Kalıp Altı İskele Sistemi

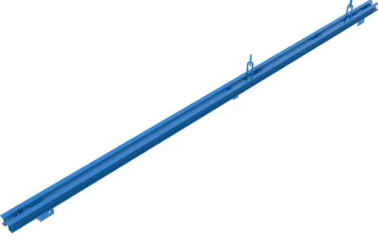

	ÜRÜN ADI Product Name	ÜRÜN KODU Product Code	BOY Size	AĞIRLIK Weight
	<b>H20 AHŞAP KİRİŞ</b> <i>H20 WOODEN BEAM</i>	61300207	290 CM	13.00 KG
		61300208	330 CM	14.90 KG
		61300209	360 CM	16.20 KG
		61300210	390 CM	17.60 KG
		61300211	450 CM	20.30 KG
	<b>AHŞAP KALAS</b> <i>WOODEN DECK</i>	61300212	5X20X300 CM	16.00 KG
		61300213	5X15X300 CM	12.00 KG
		61300214	5X15X400 CM	13.00 KG
	<b>ANA KİRİŞ</b> <i>MAIN BEAM</i>	61300215	600 CM	140.00 KG
	<b>ANA DİKME</b> <i>MAIN PROP</i>	61300216	200 CM	54.00 KG
		61300217	250 CM	60.00 KG
		61300218	300 CM	66.00 KG
		61300219	350 CM	72.00 KG

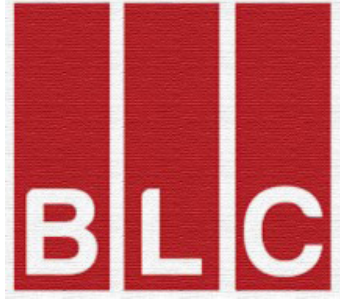

# Kalıp Altı İskele Sistemi

	ÜRÜN ADI Product Name	ÜRÜN KODU Product Code	BOY Size	AĞIRLIK Weight
	<b>GERGİ KOLU</b> <i>TENSION TUBE</i>	61300221	300 CM	25.10 KG
		61300222	325 CM	27.20 KG
		61300223	358 CM	29.50 KG
		61300224	395 CM	31.90 KG
	<b>ALIN KORKULUĞU</b> <i>GUARDRAIL</i>	61300225	145 CM	6.90 KG
		61300226	170 CM	7.70 KG
	<b>ZEMİN ANKRAJ VİDASI MULTİ MONTİ</b> <i>MULTI MONTI SCREW</i>	61300227	14X80 MM	0.10 KG
	<b>CIVATA SOMUN</b> <i>BOLT AND NUT</i>	61300228	16X60 MM	0.10 KG
		61300229	16X100 MM	0.15 KG
		61300230	27X140 MM	0.30 KG
	<b>AHŞAP VİDASI</b> <i>WOOD SCREW</i>	61300231	6X80 MM	0.01 KG

# Kalıp Altı İskele Sistemi

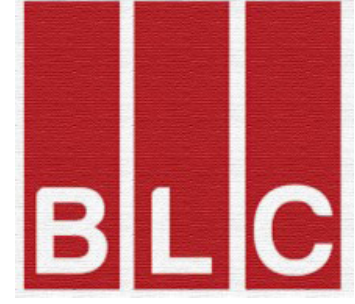

	ÜRÜN ADI Product Name	ÜRÜN KODU Product Code	BOY Size	AĞIRLIK Weight
	<b>TELESKOPIK DİKME DİREK</b> <i>TELESCOPIC PROP</i>	61300232 61300233 61300234 61300235 61300236	3.00 M 3.50 M 4.00 M 4.50 M 5.00 M	13.00 KG 14.50 KG 16.00 KG 17.50 KG 19.00 KG
	<b>TELESKOPIK DİREK UZATMA</b> <i>PROP EXTENSION COMPONENT</i>	61300237	-----	4.75 KG
	<b>ÜÇ AYAK</b> <i>TRIPOD</i>	61300238	-----	9.00 KG
	<b>MEKANİZMA</b> <i>THREADED</i>	61300238	-----	0.70 KG
	<b>SOMUN</b> <i>PROP NUT</i>	61300239	-----	0.40 KG
	<b>AYAR KANCASI</b> <i>PROP HOOK</i>	61300240	-----	0.35 KG
	<b>ÇEVİRME KOLU</b> <i>PROP HANDLE</i>	61300241	-----	0.20 KG

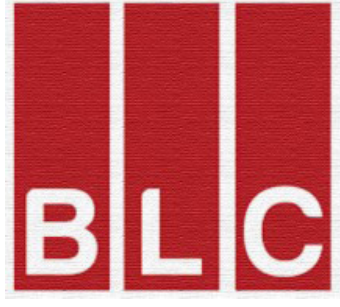

# Kalıp Altı İskele Sistemi

**ÜRÜN ADI**  
Product Name

**ÜRÜN KODU**  
Product Code

**BOY**  
Size

**AĞIRLIK**  
Weight

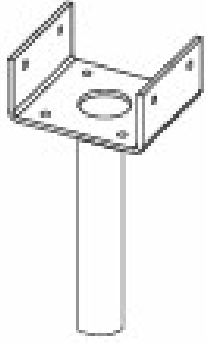

**U BAŞLIK**  
*U TYPE HEAD*

61300242

-----

0.55 KG



**DÜZ BAŞLIK**  
*FLAT HEAD*

61300243

-----

0.55 KG

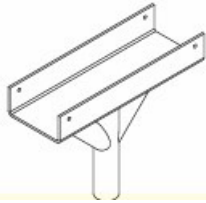

**KİRİŞ ALTI BAŞLIK**  
*BEAM HEAD*

61300244

-----

2.50 KG

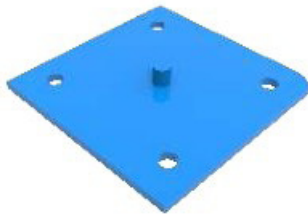

**AHŞAP KALAS**  
*WOODEN DECK*

61300220

-----

1.70 KG



‘Sizinle Yükseliyoruz’

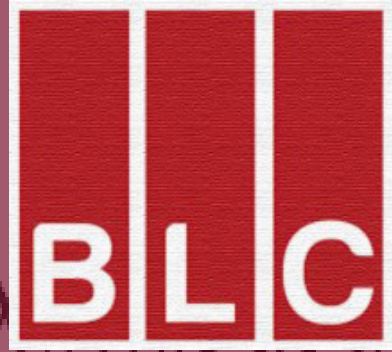

[www.blciskele.com](http://www.blciskele.com)  
[www.turkeyscaffolding.com](http://www.turkeyscaffolding.com)